

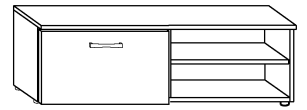

MAGIC - RTV KRÓTKI

► 96 ↑ 29 ↘ 38



x 12



(a)

x 6

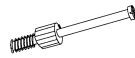

(b)

x 6



(c)

x 2

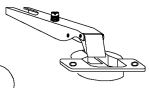

(d)

x 2

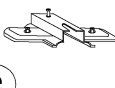

(e)

x 1

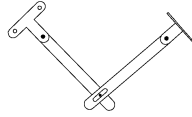

(f)

x 1

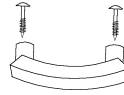

(g)

x 4

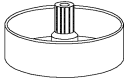

(h)

x 8 (4x16)



(i)

x 4



(j)

x 30



(k)

35 min

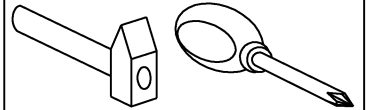
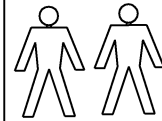

① - FAZY MONTAŻU

Ⓐ - OZNACZENIE ELEMENTÓW

Ⓐ - OZNACZENIE AKCESORIÓW

①

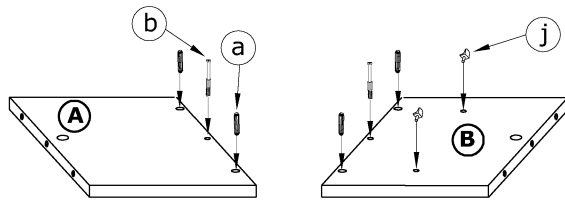

②

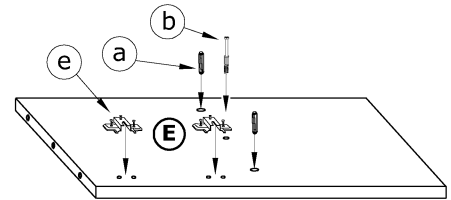

③

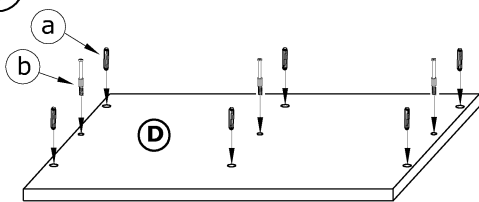

④

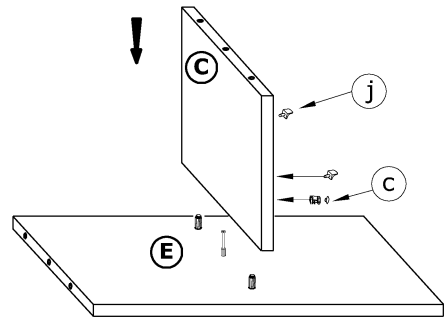

⑤

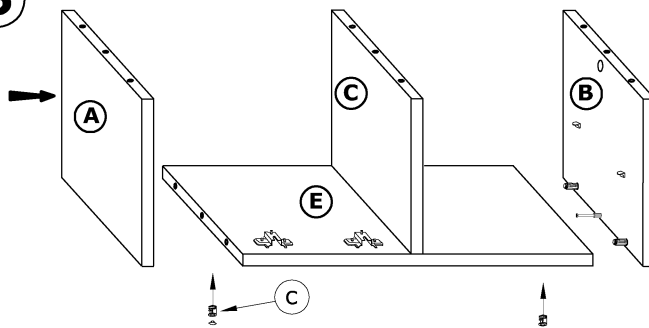

⑥

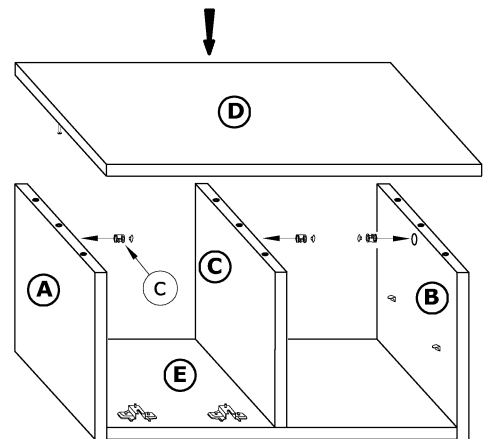

⑦

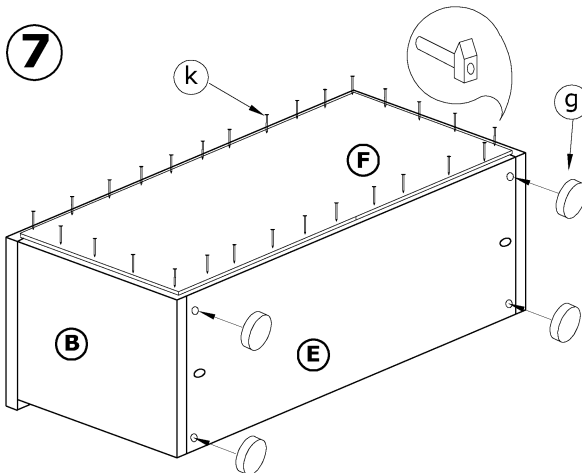

⑧

